

epopack

俊伸有限公司

Simple and sustainable

— EPOPACK storytelling packaging —



Web: www.epopack.com | Contact: info@epopack.com

HQ: No. 3, Ziqiang 1st Rd., Zhongli Dist., Taoyuan City 32063 Taiwan

CANADA Office: 383 Parkdale Ave., Suite 202, Ottawa K1Y 4R4 Canada

台灣公司地址: 32063 台灣桃園市中壢區自強一路3號



簡潔 & 永續-為您創造無限的可能

在這美的產業，我們的客戶需要的不僅僅是一個盛裝產品的容器，更是一個展現產品價值跟產品故事的媒介，一個說故事的包材。

俊伸有限公司是一家優良的化妝品包裝材料製造商與供應商。在台灣擁有30年之研發與製造經驗的我們與新設立的加拿大辦公室，為全球客戶提供許多種類且高品質之化妝品包裝。我們提供精緻的客製化服務，以滿足客戶之多樣的需求。

因為相信在化妝品包材的市場裡，可以美麗時尚，也可以同時為這個居住的環境盡一份心力。企業理念:簡單 (simple) & 永續(sustainable)，是推動著我們每天前進的動力。憑藉著過往使用各種不同材質的經驗及累積的專業知識，同時秉持著設計並生產可節省能源、可回收且具永續性包裝的使命。

我們於2005年起開始做了不同的嘗試並積極開發PET厚壁瓶(請參閱第6頁)，PET厚壁瓶系列不但保有類似玻璃的透明度及白瓷瓶的光澤感，以及不易碎裂的特性。基於環保以及愛護地球的理念，我們亦於2009年全心投入100%消費者後端回收PET (PCR PET)厚瓶製作來呼應企業理念(請參閱第19頁)。更於2011年，將企業理念注入產品設計中並推出單一材質的PET霜罐(請參閱第24頁)，不但使整個產品可以百分之百回收更提高回收的效率。

俊伸有限公司亦提供多項客製化的服務，將產品量身訂做，為產品說故事，以持續提供讓客戶滿意的服務。期待與客戶一起成長，一起創造更好的未來。

PET環保材質

PET材質擁有國際回收標誌第一號，並且有良好的物化性，適用於大部分的化妝品。PET材質亦有相當好的透明度可表現出產品的高質感。

厚壁特色

厚壁特色讓PET塑膠瓶全面升級不在只是一般傳統的塑膠瓶，PET瓶看起來像玻璃瓶的高質感，但不易破碎易於運送的優點更讓專注在電子商務市場的客戶擺脫舊有破瓶等客訴問題。

上彈簧壓頭

為了提供客戶專業的包材已完善保護產品的安全性，俊伸有限公司所提供的壓頭為上彈簧設計，上彈簧設計可確保產品內料不會直接與彈簧金屬件接觸。

1987	1990	2005	2009	2011	2019	2020	2022	2023
創立於 1987	1990 玻璃瓶 1998 AS真空瓶 1999 壓克力瓶 2000 PP真空瓶	2005 PET厚壁瓶	2009 再生PET瓶	2011 ISO 9001 2012 PET厚壁霜罐	2019 遷廠擴張	2020 合併導入 ISO9001 & ISO14001	PET 真空瓶 PET 滴管	設立加拿大辦公室 導入 EcoVadis



Simple & Sustainable - We Create Infinite Possibilities For You

EPOPACK is a manufacturer based in Taiwan with a contact office in Canada. With over 30-years experience in R&D and manufacturing we provide high quality, sustainable packaging solutions for the beauty industry. Specializing in PET heavy wall bottles, jars and airless bottles that are available in 100% PCR PET.

After years of operating in the beauty industry we know that customers need more than just a container, they need a storyteller. Good packaging tells stories and sells products. Create a unique visual identity, convey your brand message clearly, and embrace sustainability all at once with the flexibility we offer.

Our focus has remained PET material, employing a heavy wall design to provide global sustainable and high-quality packaging solutions. Our offerings are both chic and adaptable, allowing for easy customization.

Furthermore, we have been dedicated to developing 100% post consumer recycled (PCR) PET heavy-wall bottles since 2009 with ever changing developments and improvements that expand what's possible with sustainability!

Our corporate social responsibility focuses on preserving the Earth for future generations. We uphold the mission to use energy-efficient and highly sustainable materials while continuously making technological improvements and aesthetic refinements to develop a wealth of packaging options. Tell your story for years to come with Epopacks premium packaging and unparalleled customer support.



Eco-friendly PET

Package your cosmetics in fully recyclable material (international recycle code #1). PET is the most eco-friendly plastic in the world, and also has excellent physical and chemical resistance to contain nearly any cosmetic product.



Heavy wall style

Get a luxurious look and feel with your packaging. All of our PET plastic is done in the "Heavy Wall" style for a sturdy, shatterproof construction. This durable high clarity material appears glass-like, yet remains thinner and lighter.



Up-Spring system

Protect your product's purity with our special up-spring system for any pump or spray attachments. The spring is designed outside the tube leaving a free pathway so no formula comes into contact with metal.

1987	1990	2005	2009	2011	2019	2020	2022	2023
Since 1987	1990 - Glass Bottle 1998 - AS Airless Bottle 1999 - Acrylic Bottle 2000 - PP Airless Bottle	Heavy Wall PET Bottle	PCR PET Bottle	2011 - ISO 9001 2012 - PET Heavy Wall Jar	Relocation for expansion	ISO9001 ISO14001	PET airless bottle PET dropper	Set up Canada office & EcoVadis

PET HEAVY WALL BOTTLE

PET 厚壁瓶

Cylindrical 圓瓶

- 08 TR 系列 / SERIES
- 09 TD 系列 / SERIES
- 10 AX, FC 系列 / SERIES
- 11 AQ, AY, DA 系列 / SERIES
- 12 AG 系列 / SERIES
- 13 FA, DC 系列 / SERIES
- 14 FD 系列 / SERIES
- 15 AV, AU, DV 系列 / SERIES

Square 方瓶

- 16 FB, TS, TL 系列 / SERIES
- 17 AC, AE, AJ, AK, AL 系列 / SERIES

Other 其他造型

- 18 AM 系列 / SERIES
- 19 TC 系列 / SERIES
- 20 TA 系列 / SERIES
- 21 TE, TF, TO, AZ 系列 / SERIES
- 22 AA, AB, AF, AP 系列 / SERIES
- 23 AD, AN 系列 / SERIES
- 24 AH 系列 / SERIES
- 25 AO 系列 / SERIES
- 26 AI 系列 / SERIES
- 27 FF 系列 / SERIES

PET HEAVY WALL JAR

PET 厚壁霜罐

- 29 MJ6 系列 / SERIES
- 30 EJ1, PJA, PJB 系列 / SERIES

AIRLESS BOTTLE

真空瓶

PET Material

- 32 T30 系列 / SERIES
- 33 T33 系列 / SERIES

PP Material

- 34 P20 系列 / SERIES
- 35 P24 系列 / SERIES
- 36 P33 系列 / SERIES

ATTACHMENT DECORATION

配件 / 裝飾

- 38 OPTIONAL COMPONENTS
- 42 PRODUCT OVERVIEW
- 47 DECORATION OPTIONS



100% PCR PET

100% Post consumer recycled PET

100% 消費者終端回收PET

實現企業核心理念及價值，並同時塑造時尚高級質感
100% PCR PET 是您的品牌代言人，是說故事的包材。

100% PCR PET bottles and jars present the products in a sustainable yet stylish brand image. A perfect storytelling packaging for an eco-friendly brand.



- 什麼是PCR

消費者終端回收的材質

經過市場流通，可能會進入垃圾場但經消費者使用後回收，進而延續資源壽命的材質。

- 100% PCR PET

俊伸有限公司能夠提供優質的100% PCR PET 材質，讓PET後壁平能在永續以及高質感之間取得平衡。

- 為什麼100%

經過多年的研發及測試，我們發現混合新材質及消費者終端回收材質會造成生產過程中較多的浪費，失去原本使用這個永續材質的初心，因此，提供100% PCR的選項。

At EPOPACK , it's all or nothing.

- *What is PCR?*

Post Consumer Recycled

Plastic that has completed its life cycle. Recycled plastic is collected, sorted, cleaned, and made into resin pellets.

- *100% PCR PET*

Achieved by breaking down PET material to the molecular level. This allows for much of the imperfections commonly seen in PCR to be removed. You see less colour variation, dark spots, flow lines, and you can achieve a clarity that was previously impossible in heavy-wall style. Give the best of both worlds with this exciting option, it's time to expand what's possible with sustainability and EPOPACK!

- *Why only 100%?*

Consistent Production

Throughout our many years of testing and handling this material, we have determined that mixing PCR PET with virgin PET to make a lower percentage will result in a higher defect rate. To combat this unnecessary waste, we only use 100%.

At EPOPACK, it's all or nothing.

PET HEAVY WALL BOTTLE



PET厚壁瓶

PET厚壁瓶為最理想之化妝品包材，不論是其材料特性亦或是厚壁質感皆可在消費者的第一印象中將品牌價值強調出來。

Explore a diverse selection of premium packaging possibilities with EPOPACK's extensive heavy wall range, boasting a selection of 80+ high-end bottle options. These bottles come in a variety of distinctive shapes and designs, all made to fit perfectly with our attachment offerings. They emulate the elegance of glass, yet made with environmentally conscious PET plastic. With products ranging from 15ml - 200ml, these sizes offer a spectrum of upscale packaging choices that are truly unparalleled worldwide.

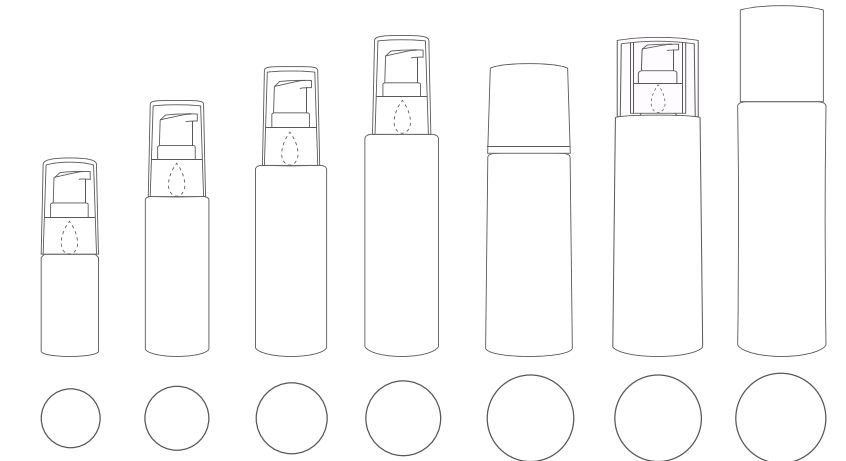

Dosage / 壓頭輸出量 : 0.2ml
 Bottle Material / 瓶身材質: PET / 100% PCR PET

ITEM 品項	Full Vol.(ml) 滿量	Dia.(mm) 直徑	H(mm) 瓶高	G.P.I. 牙口
TR4-015	17	28.0	62.0	20/410
TR6-030	32	30.4	87.5	20/410
TR7-050	58	34.0	103.5	20/410
TR6-075	77	35.0	116.9	20/410
TR6-100	106	41.0	110.8	20/410
TR7-120	124	41.0	127.8	20/410
TR7-150	154	42.0	143.6	20/410

Attachment 搭配配件	Pump+Cap 壓頭+上蓋						Reducer + serew cap 瓶口塞+旋蓋				Dropper 滴管 (● Glass / ● PET)			
	L1+ EP2424	L1+ EP3042	L1L+ EP2845A	L2 or L8 EP2845	L2+ CI2744	L8, L2, L2L,L7 EP3942	R20A+ SC2416	R20A+ SC2418	R20A+ SC2430	R20A+ SC2435	DA20	DC20	DM20	DL20
TR4-015	●		●	●	●		●	●	●	●	●	●	●	●
TR6-030	●	●	●	●	●		●	●	●	●	●	●	●	●
TR7-050	●	●	●	●	●		●	●	●	●	●	●	●	●
TR6-075	●	●	●	●	●		●	●	●	●				
TR6-100	●	●	●	●	●	●	●	●	●	●				
TR7-120	●	●	●	●	●	●	●	●	●	●				
TR7-150	●	●	●	●	●	●	●	●	●	●				

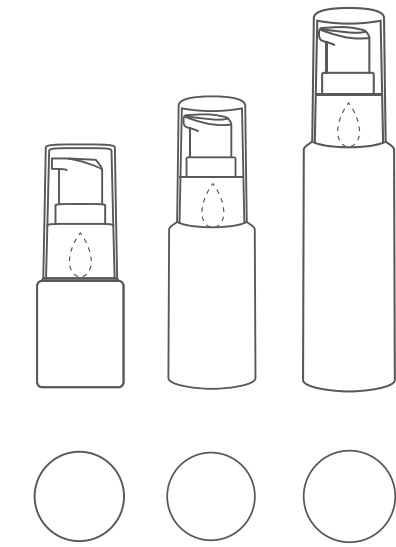

Dosage / 壓頭輸出量 : 0.2ml
 Bottle Material / 瓶身材質 : PET / 100% PCR PET

ITEM 品項	Full Vol.(ml) 滿量	Dia.(mm) 直徑	H(mm) 瓶高	G.P.I. 牙口
TD4-S15	17.0	32.0	50.5	20/410
TD4-030	38.0	33.0	74.4	20/410
TD6-050	55.0	33.0	100.5	20/410

Attachment 搭配配件	Pump+Cap 壓頭+上蓋				Reducer + serew cap 瓶口塞+旋蓋				Dropper 滴管 (● Glass / ● PET)				
	L1+ EP2424	L1+ EP3042	L1L+ EP2845A	L2 or L8 EP2845	L2+ CI2744	R20A+ SC2416	R20A+ SC2418	R20A+ SC2430	R20A+ SC2435	DA20	DC20	DM20	DL20
TD4-S15	●	●	●	●	●	●	●	●	●	●	●	●	●
TD4-030	●	●	●	●	●	●	●	●	●	●	●	●	●
TD6-050	●	●	●	●	●	●	●	●	●	●	●	●	●

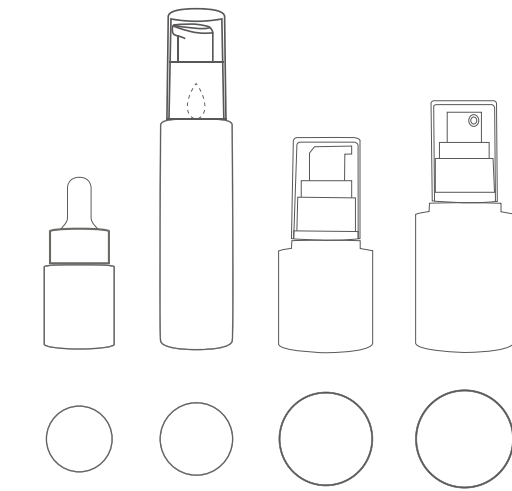

Dosage / 壓頭輸出量 : 0.2ml
 Bottle Material / 瓶身材質 : PET / 100% PCR PET

ITEM 品項	Full Vol.(ml) 滿量	Dia.(mm) 直徑	H(mm) 瓶高	G.P.I. 牙口
AX4-S18	20.0	32.5	53.8	20/410
AX6-060	64.0	32.5	116.9	20/410
FC6-030	38.0	40.2	61.0	20/415
FC8-050	58.0	42.5	76.0	20/415

Attachment 搭配配件	Pump+Cap 壓頭+上蓋				Reducer + serew cap 瓶口塞+旋蓋				Dropper 滴管 (● Glass / ● PET)				
	L1+ EP2424	L1+ EP3042	L1L+ EP2845A	L2 or L8 EP2845	L2+ CI2744	R20A+ SC2416	R20A+ SC2418	R20A+ SC2430	R20A+ SC2435	DA20	DC20	DM20	DL20
AX4-S18	●	●	●	●	●	●	●	●	●	●	●	●	●
AX6-060	●	●	●	●	●	●	●	●	●				
FC6-030	●	●	●	●	●	●	●	●	●	●	●	●	●
FC8-050	●	●	●	●	●	●	●	●	●	●	●	●	●



Dosage / 壓頭輸出量 : 0.2ml or 0.5ml
 Bottle Material / 瓶身材質: PET / 100% PCR PET

ITEM 品項	Full Vol.(ml) 滿量	Dia.(mm) 直徑	H(mm) 瓶高	G.P.I. 牙口
AQ9-100	106.0	39.0	131.3	24/410
AY9-100	107.0	39.0	131.3	24/410
AY9-150	154.0	45.0	134.0	24/410
AY1-180	195.0	45.5	158.0	24/410
DA1-200	210.0	48.2	153.3	24/415

Attachment 搭配配件	Pump+Cap 壓頭+上蓋					Reducer + serew cap 瓶口塞+旋蓋	
	B6	D1	B2 or B8/EP3144	B2 or B8/EP3247	B2 or B8/EP3850	R24B+SC4534	R24B+SC4440
AQ9-100					•		
AY9-100	•	•	•				
AY9-150	•	•	•			•	•
AY1-180	•	•	•			•	•
DA1-200	•	•		•		•	•

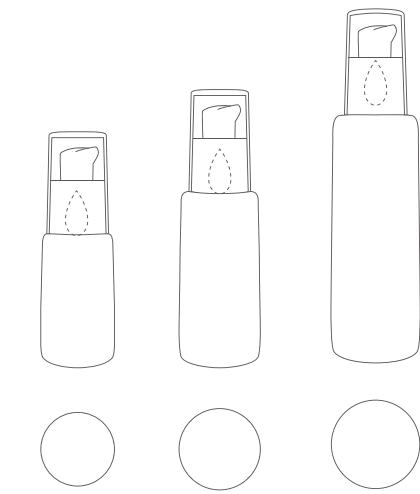

Dosage / 壓頭輸出量 : 0.2ml

Bottle Material / 瓶身材質: PET / 100% PCR PET

ITEM 品項	Full Vol.(ml) 滿量	Dia.(mm) 直徑	H(mm) 瓶高	G.P.I. 牙口
AG4-030	33.0	32.9	70.1	20/410
AG6-050	53.0	36.0	88.7	20/410
AG7-100	102.0	39.3	121.1	20/410

	Pump+Cap 壓頭+上蓋					Reducer + serew cap 瓶口塞+旋蓋				Dropper 滴管 (● Glass / ● PET)			
Attachment 搭配配件	L1+ EP2424	L1+ EP3042	L1L+ EP2845A	L2 or L8 EP2845	L2+ CI2744	R20+ SC2416	R20+ SC2418	R20+ SC2430	R20+ SC2435	DA20	DC20	DM20	DL20
AG4-030	●	●	●	●	●	●	●	●	●	●	●	●	●
AG6-050	●	●	●	●	●	●	●	●	●	●	●	●	●
AG7-100	●	●	●	●	●	●	●	●	●				

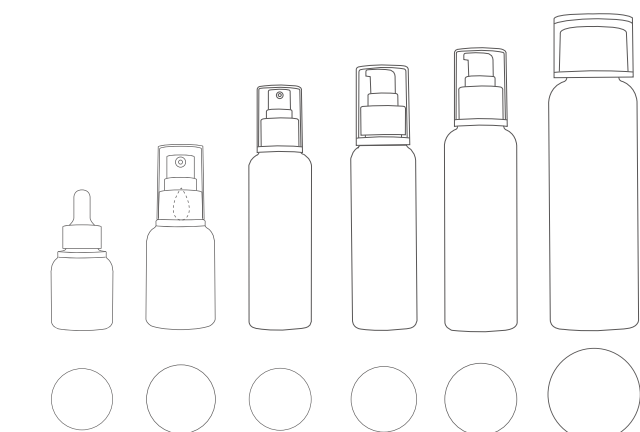

Dosage / 壓頭輸出量 : 0.2ml or 0.5ml
 Bottle Material / 瓶身材質: PET / 100% PCR PET

ITEM 品項	Full Vol.(ml) 滿量	Dia.(mm) 直徑	H(mm) 瓶高	G.P.I. 牙口
FA6-030	37.0	37.9	66.1	20/415
FA8-050	56.5	40.5	81.3	20/415
DC8-100	108.0	39.5	131.5	24/415
DC8-120	128.0	41.1	138.4	24/415
DC1-150	158.0	44.6	144.4	24/415
DC1-200	209.0	48.2	154.9	24/415

Attachment 搭配配件	Pump+Cap 壓頭+上蓋								Dropper 滴管 (● Glass / ● PET)				
	L1+ EP2424	L1+ EP3042	L1L+ EP2845A	L2 or L8 EP2845	L2+ CI2744	B6	D1	B2 or B8 EP3247	R24B+ SC4534	DA20	DC20	DM20	DL20
FA6-030	●	●	●	●	●					●	●	●	●
FA8-050	●	●	●	●	●								
DC8-100						●	●	●					
DC8-120						●	●	●					
DC1-150						●	●	●	●				
DC1-200						●	●	●	●				



FD4-S30
30ml



FD6-060
60ml



FD8-100
100ml

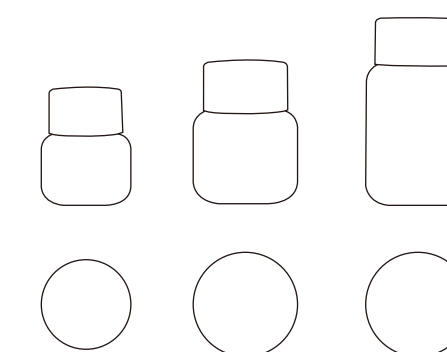

Dosage / 壓頭輸出量 : 0.2ml

Bottle Material / 瓶身材質: PET / 100% PCR PET

ITEM 品項	Full Vol.(ml) 滿量	Dia.(mm) 直徑	H(mm) 瓶高	G.P.I. 牙口
FD4-S30	38.0	43.8	51.5	20/410
FD6-060	69.0	51.0	62.5	20/415
FD8-100	110.0	51.0	86.2	20/415

Attachment 搭配配件	Pump+Cap 壓頭+上蓋					Reducer + serew cap 瓶口塞+旋蓋							Dropper 滴管 (● Glass / ● PET)			
	L1+ EP2424	L1+ EP3042	L1L+ EP2845A	L2 or L8 EP2845	L2+ CI2744	R20A+ SC2416	R20A+ SC2418	R20A+ SC2430	R20A+ SC2435	R20B+ SC3622	R20B+ SC4124	R20B+ SC4324	DA20	DC20	DM20	DL20
FD4-S30	●	●	●	●	●	●	●	●	●	●			●	●	●	●
FD6-060	●	●	●	●	●	●	●	●	●	●	●		●	●	●	●
FD8-100	●	●	●	●	●	●	●	●	●	●	●	●				



Bottle & Cap / 瓶身材質: PET / 100% PCR PET

ITEM 品項	Full Vol.(ml) 滿量	Dia.(mm) 直徑	H(mm) 瓶高	G.P.I. 牙口
AV4-030	35.0	37.0	47.0	20/410
AV6-060	75.0	41.4	74.0	20/410
AV7-120	121.0	41.7	122.9	20/410
AV7-150	154.0	43.7	132.9	20/410
AU7-120	127.0	43.7	130.6	20/410
DV1-200	213.0	54.3	111.1	24/415
DV1-300	304.0	55.0	147.9	24/415

	Reducer + serew cap 瓶口塞+旋蓋			
Attachment 搭配配件	R20B+ SC3622	R20B+ SC4124	R20B+ SC4324	R24B+ SC5429
AV4-030	•			
AV6-060		•		
AV7-120		•		
AV7-150			•	
AU7-120			•	
DV1-200				•
DV1-300				•

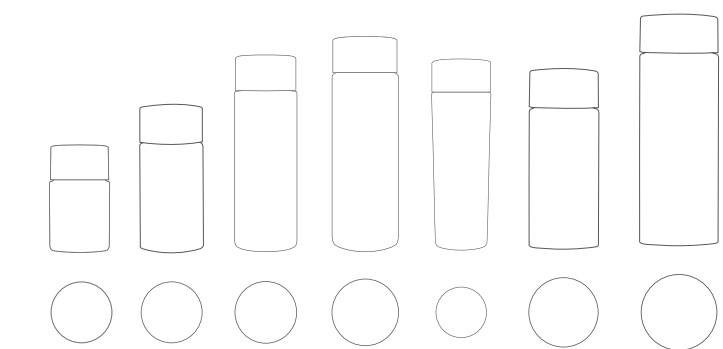

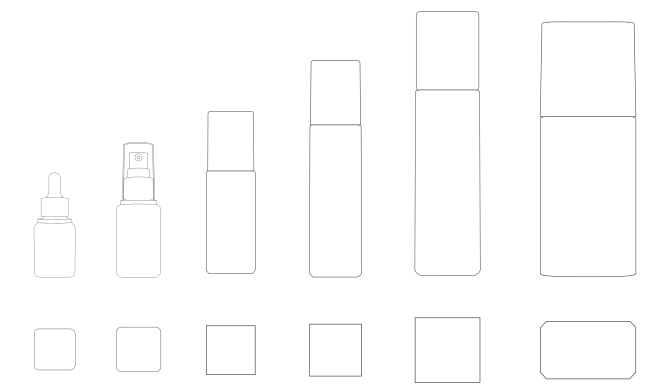

Dosage / 壓頭輸出量 : 0.2ml

Bottle Material / 瓶身材質 : PET / 100% PCR PET

ITEM 品項	Full Vol.(ml) 滿量	Dia.(mm) 直徑	H(mm) 瓶高	G.P.I. 牙口
FB6-030	37.0	35.0	62.8	20/415
FB8-050	56.0	37.0	78.0	20/415
TS6-060	70.0	34.7	88.0	20/410
TS7-090	100.0	34.7	116.75	20/410
TS9-200	217.0	43.5	148.7	24/410
TL9-200	215.0	61.0	128.1	24/410

Attachment 搭配配件	Pump+Cap 壓頭+上蓋												Reducer + serew cap 瓶口塞+旋蓋				Dropper 滴管 (● Glass / ● PET)			
	L1+ EP2424	L1+ EP3042	L1L+ EP2845A	L2 or L8 EP2845	L2+ CI2744	L2A1	L2A2BCS	B2A1	B2A2BCS	EP3342	EP3759	EP4351	R20A+ SC2416	R20A+ SC2418	R20A+ SC2430	R20A+ SC2435	DA20	DC20	DM20	DL20
FB6-030	●	●	●	●	●								●	●	●	●	●	●	●	●
FB8-050	●	●	●	●	●								●	●	●	●	●	●	●	●
TS-60						●	●			●										
TS-90						●	●			●										
TS-200								●	●		●									
TL-200								●	●			●								

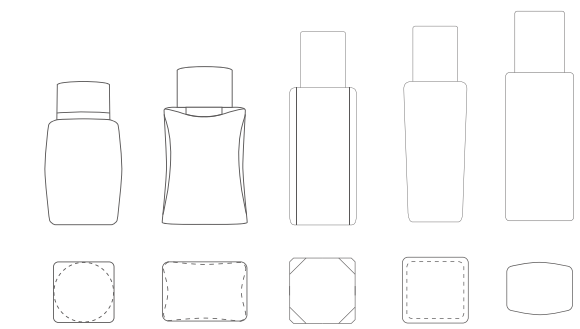

Dosage / 壓頭輸出量 : 0.2ml
 Bottle Material / 瓶身材質 : PET / 100% PCR PET

ITEM 品項	Full Vol.(ml) 滿量	Dia.(mm) 直徑	H(mm) 瓶高	G.P.I. 牙口
AC4-030	33.0	33.6	59.9	20/410
AE4-030	32.0	35.5	68.1	20/410
AJ6-050	53.0	34.0	86.0	20/410
AK6-050	53.0	34.0	91.1	20/410
AL6-050	53.0	35.0	87.5	20/410

Attachment 搭配配件	Pump+Cap 壓頭+上蓋					Reducer + serew cap 瓶口塞+旋蓋				Dropper 滴管 (● Glass / ● PET)			
	L1+ EP2424	L1+ EP3042	L1L+ EP2845A	L2 or L8 EP2845	L2+ CI2744	R20A+ SC2416	R20A+ SC2418	R20A+ SC2430	R20A+ SC2435	DA20	DC20	DM20	DL20
AC4-030	●	●	●	●	●	●	●	●	●	●	●	●	●
AE4-030	●	●	●	●	●	●	●	●	●	●	●	●	●
AJ6-050	●	●	●	●	●	●	●	●	●	●	●	●	●
AK6-050	●	●	●	●	●	●	●	●	●	●	●	●	●
AL6-050	●	●	●	●	●	●	●	●	●	●	●	●	●

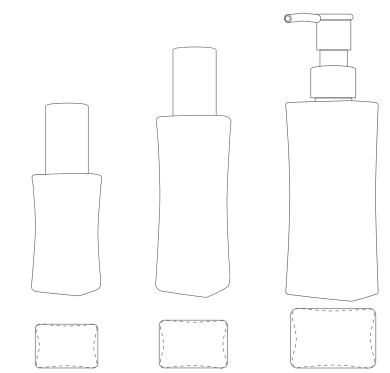

Dosage / 壓頭輸出量 : 0.2ml or 0.5ml

Bottle Material / 瓶身材質 : PET / 100% PCR PET

ITEM 品項	Full Vol.(ml) 滿量	Dia.(mm) 直徑	H(mm) 瓶高	G.P.I. 牙口
AM6-050	55.0	35.8	88.4	20/410
AM7-100	104.0	39.1	124.6	20/410
AM9-150	153.0	44.5	132.5	24/410

	Pump+Cap 壓頭+上蓋								Reducer + serew cap 瓶口塞+旋蓋				Dropper 滴管 (● Glass / ● PET)			
Attachment 搭配配件																
	L1+ EP2424	L1+ EP3042	L1L+ EP2845A	L2 or L8 EP2845	L2+ CI2744	B2 or B8 EP3144	B6	D1	R20A+ SC2416	R20A+ SC2418	R20A+ SC2430	R20A+ SC2435	DA20	DC20	DM20	DL20
AM6-050	●	●	●	●	●				●	●	●	●	●	●	●	●
AM7-100	●	●	●	●	●				●	●	●	●				
AM9-150						●	●	●								

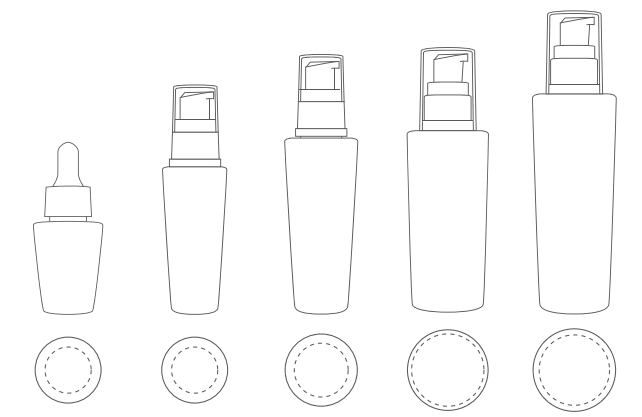

Dosage / 壓頭輸出量 : 0.2ml
 Bottle Material / 瓶身材質: PET / 100% PCR PET

ITEM 品項	Full Vol.(ml) 滿量	Dia.(mm) 直徑	H(mm) 瓶高	G.P.I. 牙口
TC4-015	19.0	34.2	58.4	20/410
TC6-030	34.0	34.0	90.7	20/410
TC7-050	61.0	38.1	106.0	20/410
TC6-100	105.0	44.0	108.8	20/410
TC7-120	124.0	44.7	127.7	20/410

Attachment 搭配配件	Pump+Cap 壓頭+上蓋					Reducer + serew cap 瓶口塞+旋蓋				Dropper 滴管 (● Glass / ● PET)			
	L1+ EP2424	L1+ EP3042	L1L+ EP2845A	L2 or L8 EP2845	L2+ CI2744	R20A+ SC2416	R20A+ SC2418	R20A+ SC2430	R20A+ SC2435	DA20	DC20	DM20	DL20
TC4-015	●	●	●	●	●	●	●	●	●	●	●	●	●
TC6-030	●	●	●	●	●	●	●	●	●	●	●	●	●
TC7-050	●	●	●	●	●	●	●	●	●	●	●	●	●
TC6-100	●	●	●	●	●	●	●	●	●	●	●	●	●
TC7-120	●	●	●	●	●	●	●	●	●	●	●	●	●

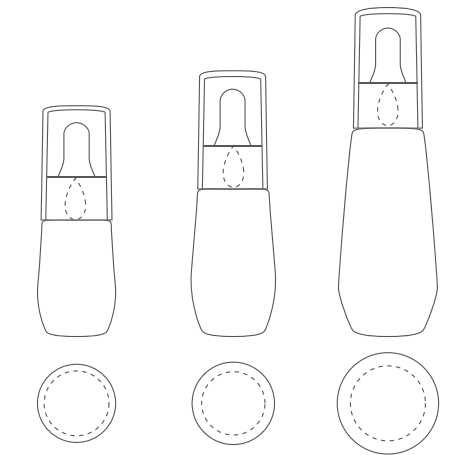

Dosage / 壓頭輸出量 : 0.2ml
 Bottle Material / 瓶身材質: PET / 100% PCR PET

ITEM 品項	Full Vol.(ml) 滿量	Dia.(mm) 直徑	H(mm) 瓶高	G.P.I. 牙口
TA4-015	20.0	32.2	59.8	20/410
TA4-030	34.0	35.1	71.8	20/410
TA6-050	54.0	38.0	94.6	20/410

Attachment 搭配配件	Pump+Cap 壓頭+上蓋				Reducer + serew cap 瓶口塞+旋蓋				Dropper 滴管 (● Glass / ● PET)				
	L1+ EP2424	L1+ EP3042	L1L+ EP2845A	L2 or L8 EP2845	L2+ CI2744	R20A+ SC2416	R20A+ SC2418	R20A+ SC2430	R20A+ SC2435	DA20	DC20	DM20	DL20
TA4-015	●	●	●	●	●	●	●	●	●	●	●	●	●
TA4-030	●	●	●	●	●	●	●	●	●	●	●	●	●
TA6-050	●	●	●	●	●	●	●	●	●	●	●	●	●



TE6-030
30ml



TF6-030
30ml



TO6-050
50ml



AZ9-100
100ml

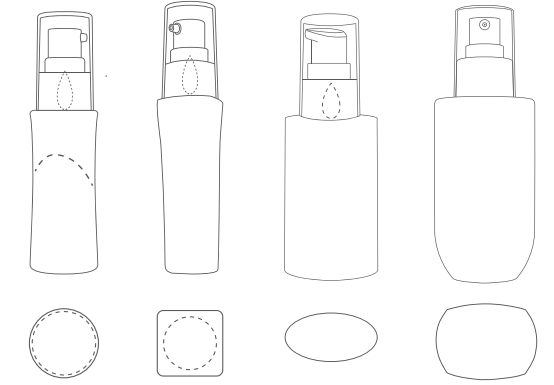

Dosage / 壓頭輸出量 : 0.2ml or 0.5ml

Bottle Material / 瓶身材質: PET / 100% PCR PET

ITEM 品項	Full Vol.(ml) 滿量	Dia.(mm) 直徑	H(mm) 瓶高	G.P.I. 牙口
TE6-030	34.0	32.0	88.6	20/410
TF6-030	33.0	29.1	97.8	20/410
TO6-050	53.0	42.9	87.6	20/410
AZ9-100	108.0	50.0	105.6	24/410

Attachment 搭配配件	Pump+Cap 壓頭+上蓋						Reducer + serew cap 瓶口塞+旋蓋				Dropper 滴管 (●Glass / ●PET)			
	L1+ EP3042	L1L+ EP2845A	L2 or L8 EP2845	L2+ CI2744	B2 or B8 EP3144	D1	R20+ SC2416	R20+ SC2418	R20+ SC2430	R20+ SC2435	DA20	DC20	DM20	DL20
TE6-030	●	●	●	●			●	●	●	●	●	●	●	●
TF6-030	●	●	●	●			●	●	●	●	●	●	●	●
TO-050	●	●	●	●			●	●	●	●	●	●	●	●
AZ9-100					●	●								



AA4-030
30ml



AB4-030
30ml



AF4-030
30ml



AP4-030
30ml

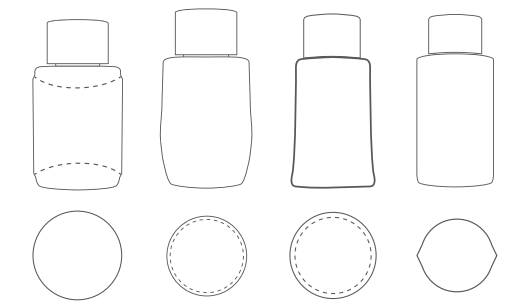

Dosage / 壓頭輸出量 : 0.2ml

Bottle Material / 瓶身材質: PET / 100% PCR PET

ITEM 品項	Full Vol.(ml) 滿量	Dia.(mm) 直徑	H(mm) 瓶高	G.P.I. 牙口
AA4-030	33.0	35.8	62.1	20/410
AB4-030	33.0	36.5	64.2	20/410
AF4-030	33.0	35.5	68.1	20/410
AP4-030	35.0	34.6	71.5	20/410

	Pump+Cap 壓頭+上蓋					Reducer + serew cap 瓶口塞+旋蓋				Dropper 滴管 (● Glass / ● PET)			
Attachment 搭配配件													
	L1+ EP2424	L1+ EP3042	L1L+ EP2845A	L2 or L8 EP2845	L2+ CI2744	R20A+ SC2416	R20A+ SC2418	R20A+ SC2430	R20A+ SC2435	DA20	DC20	DM20	DL20
AA4-030	●	●	●	●	●	●	●	●	●	●	●	●	
AB4-030	●	●	●	●	●	●	●	●	●	●	●	●	
AF4-030	●	●	●	●	●	●	●	●	●	●	●	●	
AP4-030	●	●	●	●	●	●	●	●	●	●	●	●	

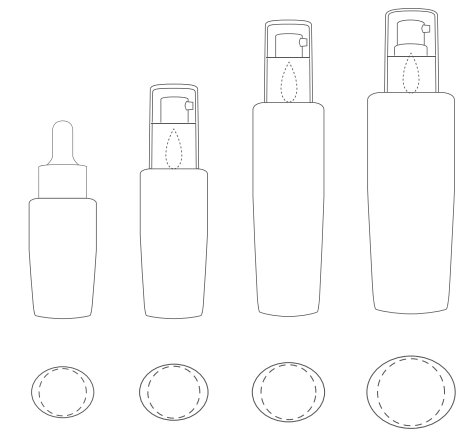

Dosage / 壓頭輸出量 : 0.2ml or 0.5ml
 Bottle Material / 瓶身材質 : PET / 100% PCR PET

ITEM 品項	Full Vol.(ml) 滿量	Dia.(mm) 直徑	H(mm) 瓶高	G.P.I. 牙口
AD4-030	34.0	36.5	70.2	20/410
AN6-050	54.0	37.5	95.4	20/410
AN7-100	104.0	40.0	132.7	20/410
AN9-150	155.0	48.8	136.7	24/410

Attachment 搭配配件	Pump+Cap 壓頭+上蓋								Reducer + serew cap 瓶口塞+旋蓋				Dropper 滴管 (● Glass / ● PET)			
	L1+ EP2424	L1+ EP3042	L1L+ EP2845A	L2 or L8 EP2845	L2+ CI2744	B2 or B8 EP3144	D1	B6	R20A+ SC2416	R20A+ SC2418	R20A+ SC2430	R20A+ SC2435	DA20	DC20	DM20	DL20
AD4-030	●	●	●	●	●				●	●	●	●	●	●	●	●
AN6-050	●	●	●	●	●				●	●	●	●	●	●	●	●
AN7-100	●	●	●	●	●				●	●	●	●				
AN9-150						●	●	●								

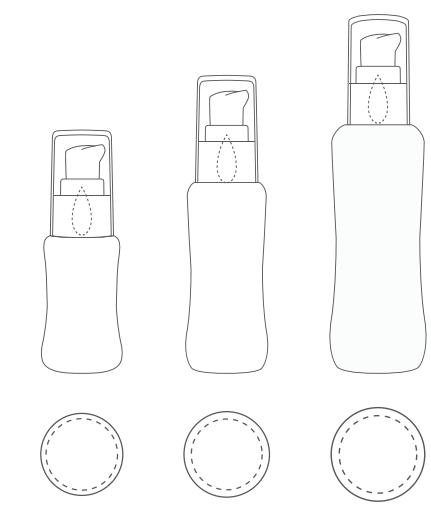

Dosage / 壓頭輸出量 : 0.2ml
 Bottle Material / 瓶身材質: PET / 100% PCR PET

ITEM 品項	Full Vol.(ml) 滿量	Dia.(mm) 直徑	H(mm) 瓶高	G.P.I. 牙口
AH4-030	33.0	35.5	72.0	20/410
AH6-050	54.0	37.5	95.5	20/410
AH7-100	104.0	43.3	119.2	20/410

Attachment 搭配配件	Pump+Cap 壓頭+上蓋					Reducer + serew cap 瓶口塞+旋蓋				Dropper 滴管 (● Glass / ● PET)			
	L1+ EP2424	L1+ EP3042	L1L+ EP2845A	L2 or L8 EP2845	L2+ CI2744	R20A+ SC2416	R20A+ SC2418	R20A+ SC2430	R20A+ SC2435	DA20	DC20	DM20	DL20
AH4-030	●	●	●	●	●	●	●	●	●	●	●	●	●
AH6-050	●	●	●	●	●	●	●	●	●	●	●	●	●
AH7-100	●	●	●	●	●	●	●	●	●				

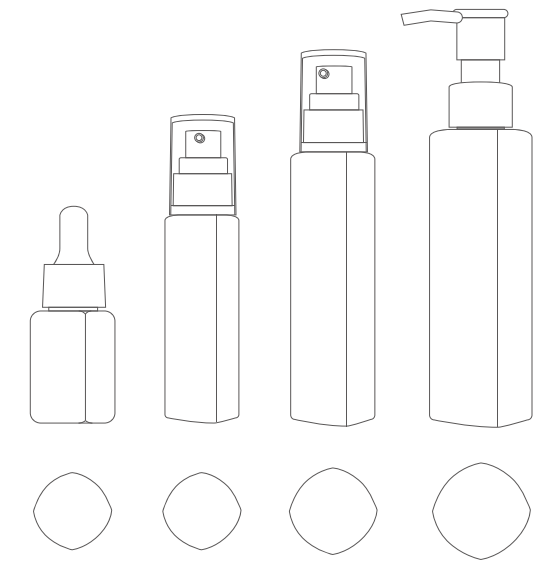

Dosage / 壓頭輸出量 : 0.2ml or 0.5ml
 Bottle Material / 瓶身材質 : PET / 100% PCR PET

ITEM 品項	Full Vol.(ml) 滿量	Dia.(mm) 直徑	H(mm) 瓶高	G.P.I. 牙口
AO4-S15	20.0	30.7	54.7	20/410
AO6-050	55.0	34.1	104.5	20/410
AO7-100	104.0	36.4	131.0	20/410
AO9-150	153.0	43.0	137.3	24/410

Attachment 搭配配件	Pump+Cap 壓頭+上蓋							Reducer + serew cap 瓶口塞+旋蓋					Dropper 滴管 (● Glass / ● PET)				
	L1+ EP2424	L1+ EP3042	L1L+ EP2845A	L2 or L8 EP2845	L2+ CI2744	B2 or B8 EP3144	D1	R20A+ SC2416	R20A+ SC2418	R20A+ SC2430	R20A+ SC2435	R24B+ SC4534	R24B+ SC4440	DA20	DC20	DM20	DL20
AO4-S15	●	●	●	●	●			●	●	●	●			●	●	●	●
AO6-050	●	●	●	●	●			●	●	●	●						
AO7-100	●	●	●	●	●			●	●	●	●						
AO9-150						●	●					●	●				

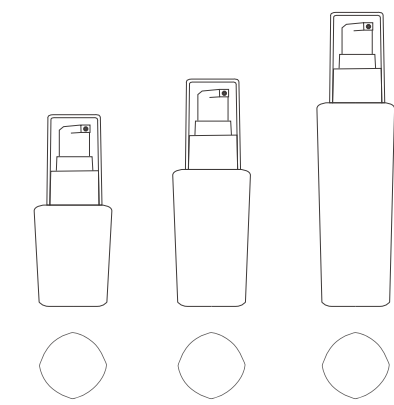

Dosage / 壓頭輸出量 : 0.2ml

Bottle Material / 瓶身材質: PET / 100% PCR PET

ITEM 品項	Full Vol.(ml) 滿量	Dia.(mm) 直徑	H(mm) 瓶高	G.P.I. 牙口
AI4-030	37.0	39.2	63.55	20/410
AI6-050	62.0	41.9	68.55	20/410
AI7-100	108.0	41.8	127.9	20/410

	Pump+Cap 壓頭+上蓋					Reducer + serew cap 瓶口塞+旋蓋				Dropper 滴管 (● Glass / ● PET)			
Attachment 搭配配件													
	L1+ EP2424	L1+ EP3042	L1L+ EP2845A	L2 or L8 EP2845	L2+ CI2744	R20A+ SC2416	R20A+ SC2418	R20A+ SC2430	R20A+ SC2435	DA20	DC20	DM20	DL20
AI4-030	●	●	●	●	●	●	●	●	●	●	●	●	●
AI6-050	●	●	●	●	●	●	●	●	●	●	●	●	●
AI7-100	●	●	●	●	●	●	●	●	●				

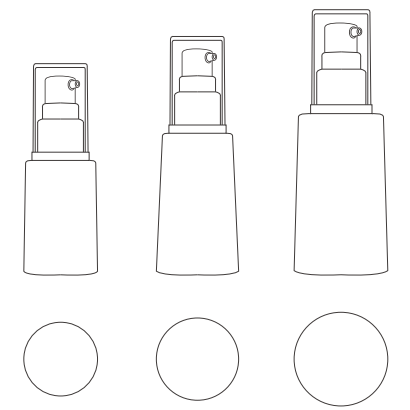

Dosage / 壓頭輸出量 : 0.2ml

Bottle Material / 瓶身材質: PET / 100% PCR PET

ITEM 品項	Full Vol.(ml) 滿量	Dia.(mm) 直徑	H(mm) 瓶高	G.P.I. 牙口
FF8-030	40.0	39.0	75.5	20/415
FF9-050	58.0	41.6	87.3	20/415
FF9-075	82.0	45.6	93.0	20/415

Attachment 搭配配件	Pump+Cap 壓頭+上蓋					Reducer + serew cap 瓶口塞+旋蓋						Dropper 滴管 (● Glass / ● PET)			
	L1+ EP2424	L1+ EP3042	L1L+ EP2845A	L2 or L8 EP2845	L2+ CI2744	R20A+ SC2416	R20A+ SC2418	R20A+ SC2430	R20A+ SC2435	R20B+ SC3622	R20B+ SC4124	DA20	DC20	DM20	DL20
FF8-030	●	●	●	●	●	●	●	●	●	●		●	●	●	●
FF9-050	●	●	●	●	●	●	●	●	●	●		●	●	●	●
FF9-075	●	●	●	●	●	●	●	●	●	●	●	●	●	●	●



HEAVY WALL JAR

厚壁霜罐

PET厚壁罐以單一材質的設計理念重新定義了環保包材使包材在使用完畢後易於回收

EPOPACK's PET heavy wall jars key feature is the simplicity. They are a testament to years of innovation and thoughtful design all brought together in one form with sizes ranging from 10ml -100ml. Made with a mono-material concept, the jar base, cap, and lid are all made of PET or 100% PCR PET. When it comes to recycling it is important to make it as easy as possible, using a mono material option simplifies the separation process and ensures a seamless user experience from start to finish.



MJ6-010
10ml

MJ6-015
15ml

MJ6-030
30ml

MJ6-050
50ml

MJ6-100
100ml

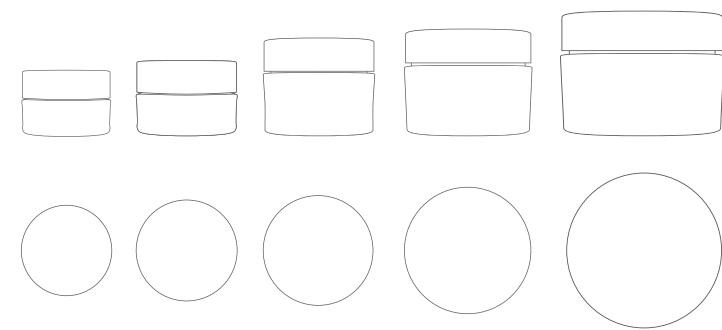

ITEM 品項	Full Vol.(ml) 滿量	Dia.(mm) 直徑	Ha(mm) 瓶高	Hb(mm) 總高
MJ6-010	12.0	40.5	24.8	28.8
MJ6-015	17.0	44.0	28.0	31.2
MJ6-030	34.0	48.5	36.7	36.7
MJ6-050	58.0	57.2	41.0	41.0
MJ6-100	119.5	67.4	54.9	57.8

Part	Material
Cap	PET / 100% PCR PET
Lid	PET / 100% PCR PET
Base	PET / 100% PCR PET



ITEM 品項	Full Vol.(ml) 滿量	Dia.(mm) 直徑	Ha(mm) 瓶高	Hb(mm) 總高
EJ1-030	34.0	51.01	40.1	49.6
PJA-007	7.0	31.11	23.5	27.5
PJB-007	7.0	31.11	23.5	27.5

Part	EJ1-30 Material
Inner/Outer Cap	PET / 100% PCR PET
Lid	PET / 100% PCR PET
Base	PET / 100% PCR PET

Part	PJA / PJB Material
Cap / Liner	PP / PE
Base	PP

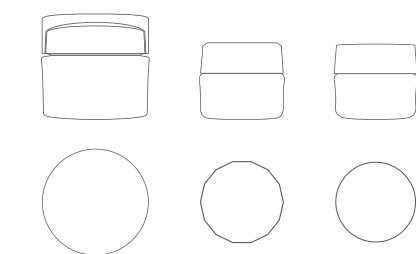



AIRLESS BOTTLES

真空瓶

不同材質的真空瓶包材提供客戶不同設計的樣式，及視內料之需求選擇適合的瓶器。穩定的品質服務及優良的產品設計塑造專業的品牌形象。低殘留量的優點讓最後一滴也不浪費。

With a variety of recyclable materials and attachments to choose from, EPOPACK's airless bottle lines provide many possibilities for design and formula. Sizes currently range from 7ml - 50ml to suit your needs and fit your image. We constantly strive to offer more sustainable options and now include PET airless bottles within the line. Perfect quality and the professional look created with the airless bottle system ensures that even the last drop in the bottle is reachable.

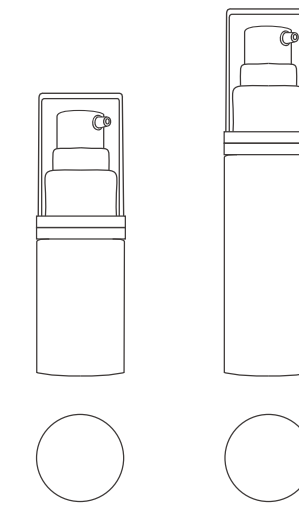

Dosage / 壓頭輸出量 : 0.2ml

ITEM 品項	Full Vol.(ml) 滿量	Dia.(mm) 直徑	Ha(mm) 瓶高	Hb(mm) 總高	G.P.I. 牙口
T30-015	17.0	30.7	63.3	92.9	20/410
T30-030	32.0	30.7	91.5	121.0	20/410

Part	Material
Cap	PET
Actuator	PP/Aluminum
Pump	PP/Aluminum
Bottle	PET
Base	PET

Attachment 搭配配件	Pump+Cap 壓頭+上蓋				
	L1L	L2	L2L	L8	L7
T30-015	•	•	•	•	•
T30-030	•	•	•	•	•

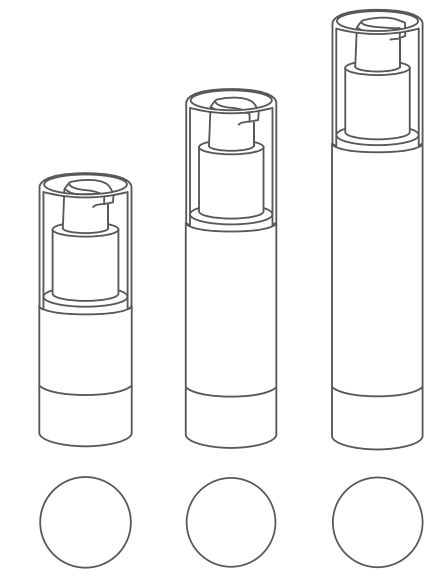

Dosage / 壓頭輸出量：0.2ml

ITEM 品項	Full Vol.(ml) 滿量	Dia.(mm) 直徑	Ha(mm) 瓶高	Hb(mm) 總高	G.P.I. 牙口
T33-015	22.0	33.3	63.7	91.4	20/410
T33-030	39.0	33.3	95.0	122.6	20/410
T33-050	57.0	33.3	123.5	151.2	20/410

Part	Material
Cap	PET
Actuator	PP / Aluminum
Pump	PP / Aluminum
Bottle	PET
Base	Aluminum

Attachment 搭配配件	Pump+Cap 壓頭+上蓋					
	L1	L1L	L2	L2L	L8	L7
T33-015	•	•	•	•	•	•
T33-030	•	•	•	•	•	•
T33-050	•	•	•	•	•	•



P20-010
10ml

P20-015
15ml

P20-018
18ml

Dosage / 壓頭輸出量 : 0.2ml

ITEM 品項	Full Vol.(ml) 滿量	Dia.(mm) 直徑	Ha(mm) 瓶高	Hb(mm) 總高	G.P.I. 牙口
P20-010	14.0	21.0	84.0	120.8	18/400
P20-015	17.0	21.0	103.9	140.4	18/400
P20-018	20.0	21.0	103.9	140.4	18/400

Part	Material
Cap	PP
Actuator	PP
Pump	PP
Bottle	PP

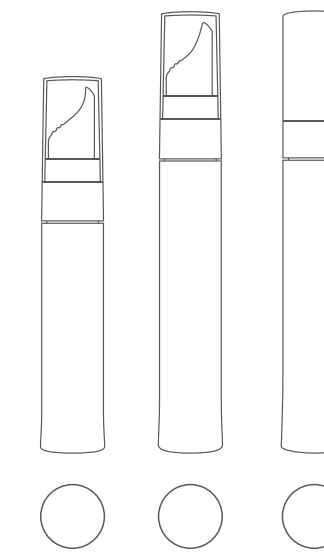

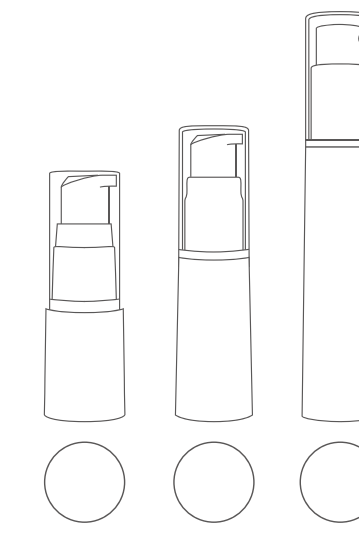

Dosage / 壓頭輸出量 : 0.2ml

ITEM 品項	Full Vol.(ml) 滿量	Dia.(mm) 直徑	Ha(mm) 瓶高	Hb(mm) 總高	G.P.I. 牙口
P24-007	11.0	25.6	50.7	78.8	18/415
P24-015	18.0	25.6	71.0	99.2	18/415
P24-030	34.0	25.6	110.3	138.2	18/415

Part	Material
Cap	AS
Actuator	PP / Aluminum
Pump	PP / Aluminum
Bottle	PP

	Pump+Cap 壓頭+上蓋		
Attachment 搭配配件			
	C1	C2	C2L
P24-007	•	•	•
P24-015	•	•	•
P24-030	•	•	•

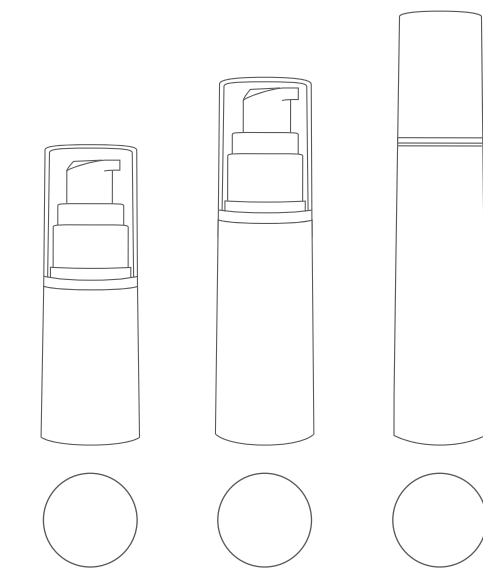

Dosage / 壓頭輸出量 : 0.2ml

ITEM 品項	Full Vol.(ml) 滿量	Dia.(mm) 直徑	Ha(mm) 瓶高	Hb(mm) 總高	G.P.I. 牙口
P33-015	24.0	32.6	66.7	96.3	20/410
P33-030	37.0	32.6	90.6	118.0	20/410
P33-050	59.0	32.6	121.6	151.2	20/410

Part	Material
Cap	AS
Actuator	PP / Aluminum
Pump	PP / Aluminum
Bottle	PP

Attachment 搭配配件	Pump+Cap 壓頭+上蓋					
	L1	L1L	L2	L2L	L8	L7
P33-015	•	•	•	•	•	•
P33-030	•	•	•	•	•	•
P33-050	•	•	•	•	•	•

ATTACHMENT

配件

各式配件可依據牙口尺寸搭配瓶身，根據產品需求混搭出獨特的樣式亦可客製化呈現多樣性的品牌風格。

EPOPACK offers a wide range of attachments that can be mixed and matched with their bottles to create the perfect combination for any beauty brand. They are designed to fit perfectly with EPOPACK's range of bottles, providing a secure and seamless connection. This flexible system ensures you will always have the function you need on any bottle option we offer. EPOPACK gives beauty brands the flexibility to create completed customized packaging solutions that perfectly match their product lines.



Actuator 按鈕



A1 A2BCS A5 A9 A3MP A3MPS

Collar + Cap 中束+上蓋



L1/EP2424 L1/EP3042 L1L/EP2845A L8/EP2845 L2/EP2845 L2L/EP2845 L7/EP2845 L2, L2L, L7 CI2744 L2, L2L, L7 CI2744A L8, L2, L2L, L7 EP3942

PET cap, PP collar

PET cap, Aluminum collar

Aluminum cap
Aluminum collar

PP cap
Aluminum or PP Collar

Reducer+Screw Cap 瓶口塞+旋蓋



R20A SC2416 SC2418 SC2430 SC2435

DUAL-SEAL CAP



雙層防漏設計

這款PET 的旋蓋擁有特殊的雙層防漏設計，專為油類產品設計

- 第一道防漏設計是在蓋內的中心，有一個止水柱可以契合的塞住瓶口塞的開口。
- 第二道防漏設計是蓋內圍繞著止水柱的止水圈，止水圈在合蓋後會施加壓力在瓶口塞上形成第二道防漏。特別適合化妝水、卸妝油、按摩油、髮油、精華液等產品。
- 這款旋蓋是由PET材質生產製造的，可以在全世界輕易的被回收再利用，是相當環保的材質PET材質更讓這款
- 旋蓋擁有可以全透明的特性，凸顯產品以及品牌的風格。
- 這款旋蓋可以搭配多款PET厚壁瓶，特別是搭配AV系列的合肩設計，特別乾淨俐落。

- Best for tricky leakage prone formulations!

- Simple and easy usage!

Epopack's dual seal cap features a stopper pin located in the center of the cap that plugs into the opening of the reducer. The stopper helps provide a first layer of protection against leakage. In addition to the stopper, the cap also includes a seal ring around it. The seal ring is designed to add additional pressure to the surface of the reducer, creating a second seal to provide additional protection against leakage.

This dual seal function helps to ensure that the product stays securely contained inside the bottle, even when it is being transported or stored!

Reducer + PET Screw Cap				Part	Material
				Reducer	PE or PP
				Cap	PET

推薦AV(P17), FF(P29), FD series(P16)
 featured AV(P17), FF(P29), FD series(P16)

SHATTERPROOF PET DROPPER



PET防碎滴管

這款PET 的旋蓋擁有特殊的雙層防漏設計，專為油類產品設計

俊伸有限公司的PET滴管有高強度防碎，可高度客製化跟可高度回收再利用的特性，中束以及滴管都是由PET回收材質生產製造而成，亦可以使用100% PCR PET消費者終端回收PET材質生產製造，這部分的設計突顯了我們對永續環境的重視，PET的滴管取代了傳統的玻璃滴管，讓產品更加安全耐用，除此之外，在轉換成PET材質以後，有色滴管的客製化需求變得更加容易，PET滴管的設計體現了俊伸有限公司在產品設計上前瞻性的思維，讓產品在環保永續性跟實用性之間達到平衡

- Safe and durable shatterpro of design!

- Simple to recycle!

Epopak's PET dropper is designed to be shatterproof, customizable, and recyclable. The collar and tube are made of PET, with 100% Post-Consumer Recycled (PCR) options available, showcasing a commitment to environmental responsibility. The shatterproof PET tube prioritizes safety and durability, and its easy customization allows for a personalized branding solution. This design achieves a balance between sustainability and practicality, reflecting a conscientious and forward-thinking approach.

Dropper



DA20



DC20



DM20



DL20

Part	Material
Bulb	Silicon / NBR
Collar	PET/100% PCR PET/Aluminum-Dia.: 24mm(DA,DM) or 28mm(DC,DL)
Tube/ Pipette	PET/100% PCR PET-Length: 73mm, 63mm and 53mm Glass - multiple size

Actuator 按鈕 Collar + Cap 中束+上蓋



A1



A2BCS



A5



A9



A3MP



B8/EP3247

PET cap
PP collar



B2/EP3144

PET cap
Aluminum collar

Lotion Pump 壓頭 Reducer+Screw Cap 瓶口塞+旋蓋



B6



D1



SC4534



SC4440



R24B

PET Heavy Wall Bottle



TR4-015
15ml



TC4-015
15ml



TA4-015
15ml



TD4-S15
15ml



AO4-S15
15ml



AX4-S18
18ml

Airless Bottle

Heavy Wall Jar



P24-007
7ml



P20-010
10ml



P24-015
15ml



P33-015
15ml



T30-015
15ml



T33-015
15ml



P20-015
15ml



P20-018
18ml



PJA-007
7ml



PJA-007
7ml



MJ6-010
10ml



MJ6-015
15ml

PET Heavy Wall Bottle



Airless Bottle



PET Heavy Wall Jar



PET Heavy Wall Bottle



TR7-050
50ml



TD6-050
50ml



AG6-050
50ml



TC7-050
50ml



TA6-050
50ml



TO6-050
50ml



AJ6-050
50ml



AK6-050
50ml



AL6-050
50ml



AM6-050
50ml



AN6-050
50ml



AI6-050
50ml



FF9-050
50ml



AO6-050
50ml



AH6-050
50ml



FA8-050
50ml



FB8-050
50ml



FC8-050
50ml



TS6-060
60ml



AX6-060
60ml



FD6-060
60ml



AV6-060
60ml



TR6-075
75ml



FF9-075
75ml



TS7-090
90ml

Airless Bottle



T33-050
50ml



P33-050
50ml

PET Heavy Wall Jar



MJ6-050
50ml

PET Heavy Wall Bottle



TR6-100
100ml



AG7-100
100ml



DC8-100
100ml



TC6-100
100ml



AM7-100
100ml



AN7-100
100ml



AO7-100
100ml



AH7-100
100ml



AZ9-100
100ml



AY9-100+D1
100ml



AQ9-100
100ml



FD8-100
100ml



AI7-100
100ml



MJ6-100
100ml

PET Heavy Wall Jar

PET Heavy Wall Bottle



TR7-120
120ml



DC8-120
120ml



TC7-120
120ml



AU7-120
120ml



AV7-120
120ml



TR7-150
150ml



DC1-150
150ml



AM9-150
150ml



AN9-150
150ml



AO9-150
150ml



AV7-150
150ml



AY9-150
150ml



AY1-180
180ml



DC1-200
200ml

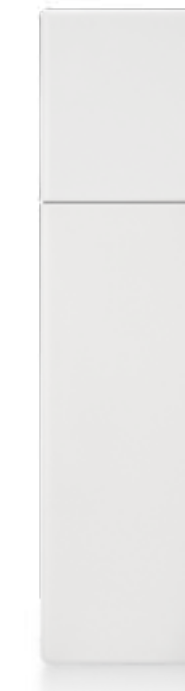

TL9-200
200ml



TL-200
200ml



DA1-200
200ml



DECORATION OPTIONS

裝飾加工

Reward decoration options:

BOTTLE - spray coating, injection colour, printing, hot stamping

CAP - spray coating, injection colour, printing, hot stamping

PUMP / ACTUATOR - injection colour, custom metallization